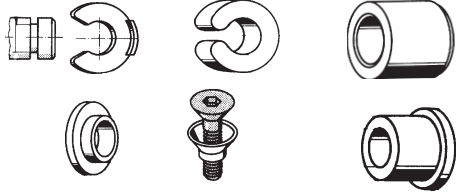
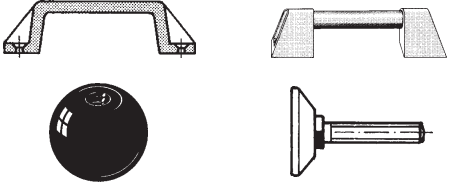
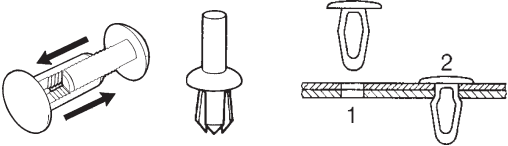
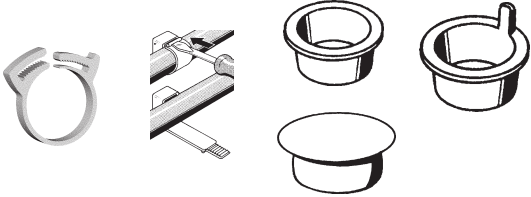

INNHALDSFORTEGNELSE AVSNITT D

Plastartikler

	<p>Feste / låseklips Isolasjonsmansjetter Glidelagre</p>	<p>2 - 5</p>
	<p>Håndtak Kulehåndtak Justerbar fot</p>	<p>6 - 7</p>
	<p>Nagler Snip & Snap</p>	<p>8 - 11</p>
	<p>Slangeklemmer Rørfeste Propper</p>	<p>12 - 17</p>
	<p>Ventilasjonsdeksler</p>	<p>18</p>
	<p>Lamellplugger Rørhetter Rørplugger Beskyttelseshetter</p>	<p>19 - 25</p>
	<p>Bein Murplugger Plomber Bevegelsesdempere</p>	<p>26 - 29</p>

D

ELRA

ELRA AS
 Tvetenveien 164
 Postboks 98, Tveita
 0617 Oslo
 Telefon: 22 75 51 00 Internet: www.elra.no
 Telefaks: 22 75 51 07 e-post: elra@elra.no

Festeklips

Materiale: POM

011

Farge: naturell

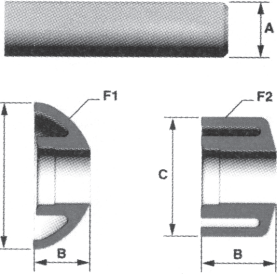
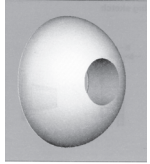

A	B	C	F	Type nr
3	5	12,5	F1	011 0030
4	5,5	14,5	F1	011 0040
5	5,5	14,5	F1	011 0050
6	6	16	F1	011 0060
6	8	13	F2	011 0061
7	8	13	F2	011 0071
8	5,5	16	F1	011 0080
10	7,5	21	F1	011 0100
12	7,5	21	F1	011 0120

011-1

Farge: rød

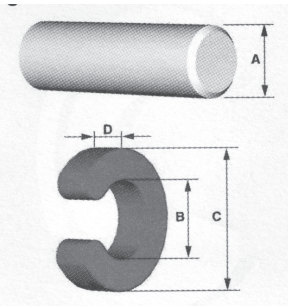
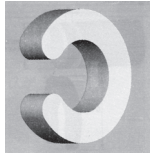

A	B	C	D	Type nr.
3	2,5	6	2	011 1030
4	3,5	7,5	2,5	011 1040
5	4,5	9	2,5	011 1050
6	5,3	11	3	011 1060
8	7	13	3	011 1080
10	9	16	3,5	011 1100
12	11	19	4	011 1120

011-2

Farge: sort

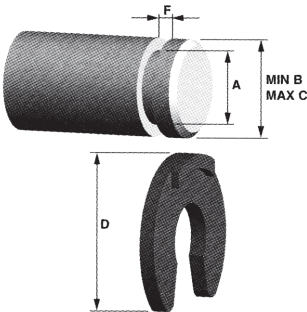

A	B	C	D	Type nr.
2,3	3	4	6	011 2023
3,2	4	5	7	011 2032
4	5	7	9	011 2040
5	6	8	11	011 2050
6	7	11	14	011 2060
7	8	11	14	011 2070
9	10	14	18,5	011 2090
12	13	18	23	011 2120

Isolasjonsmansjett

Materiale: Nylon 6

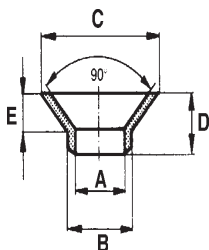

A	B	C	D	E	TYPE NR.
3,1	4,9	8,2	3,7	1,7	083 0302
4,1	5,9	10,4	4,3	2,3	083 0402
5,1	6,9	12,4	4,8	2,8	083 0502
6,1	7,9	14,4	5,3	3,3	083 0602
8,1	9,9	18,6	6,4	4,4	083 0802
10,1	12,4	22,5	10,3	5,0	083 1005
12,1	13,9	26,8	8,5	6,5	083 1202

Isolasjonsmansjett

Materiale: Nylon 6

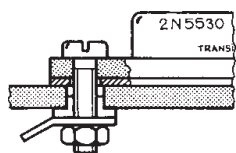
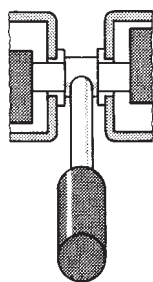
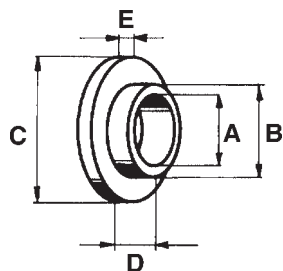

	A	B	C	D	E	TYPE NR.
	2,1	3,3	6	2,5	1,0	018 0200
	2,6	3,9	10	3	1,3	018 0250
	3,1	3,9	10	3	1,3	018 0300
	3,1	4,9	10	3	1,3	018 0301
	3,1	5,9	10	3	1,3	018 0302
	3,1	6,9	15,	3,5	1,5	018 0303
	3,1	7,9	15	3,5	1,5	018 0304
	3,1	8,9	15	3,5	1,5	018 0305
	3,1	9,9	15	3,5	1,5	018 0306
	3,1	10,9	18	3,5	1,5	018 0307
	4,2	4,9	10	3	1,3	018 0400
	4,2	5,9	10	3	1,3	018 0401
	4,2	6,9	15	3,5	1,5	018 0402
	4,2	7,9	15	3,5	1,5	018 0403
	4,2	8,9	15	3,5	1,5	018 0404
	4,2	9,9	15	3,5	1,5	018 0405
	4,2	10,9	18	3,5	1,5	018 0406
	4,2	11,9	18	3,5	1,5	018 0407
	5,2	5,9	10	3	1,3	018 0500
	5,2	6,9	15	3,5	1,5	018 0501
	5,2	7,9	15	3,5	1,5	018 0502
	5,2	8,9	15	3,5	1,5	018 0503
	5,2	9,9	15	3,5	1,5	018 0504
	5,2	10,9	18	3,5	1,5	018 0505
	5,2	11,9	18	3,5	1,5	018 0506
	6,1	6,9	15	3,5	1,5	018 0600
	6,2	7,9	15	3,5	1,5	018 0601
	6,2	8,9	15	3,5	1,5	018 0602
	6,2	9,9	15	3,5	1,5	018 0603
	6,2	10,9	18	3,5	1,5	018 0604
	6,2	11,9	18	3,5	1,5	018 0605
	8,2	8,9	15	3,5	1,5	018 0800
	8,2	9,9	15	3,5	1,5	018 0801
	8,2	10,9	18	3,5	1,5	018 0802
	8,2	11,9	18	3,5	1,5	018 0803
	10,2	10,9	18	3,5	1,5	018 1000
	10,2	11,9	18	3,5	1,5	018 1001
	10,2	12,9	19	3,5	1,5	018 1001
	12,2	13,8	25	4	2	018 1200
	12,2	14,8	25	4	2	018 1201
	12,2	15,8	25	4	2	018 1202
	12,2	17,8	25	4	2	018 1203
	14,2	15,8	25	4	2	018 1400
	14,2	17,8	25	4	2	018 1401
	16,2	17,8	25	4	2	018 1600
	18,2	21,8	36	6	3	018 1801
	20,1	21,8	36	6	3	018 2000

D

Glidelager

Materiale: Nylon 6.6

Laget av selvsmørende Polyamid (Nylon) 6.6
Litefølsom for skitt, værpåvirkning og de fleste
kjemikalier.
Tilpasset DIN h6-H7 passning.
Etter montering er lagerklaringen ca 1%
av akseldiameteren

Egner seg godt for:
- Lydløse hengsler
- Maskindeler med lavt turtall
- Elektrisk isolasjon mellom aksel og lagerhus

Se også neste side

Med flens

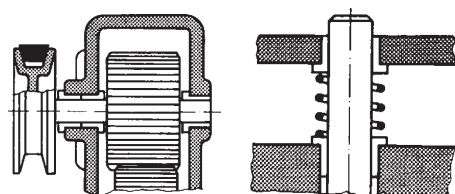
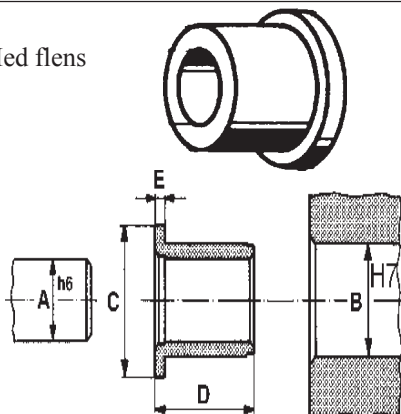

A	B	C	D	E	TYPE NR.
3,0	5,0	8	7	2,2	008 0300
4,0	6,0	9	8	2	008 0400
5,0	8,0	11	10	2	008 0500
6,0	9,0	12	6	2	008 0610
6,0	9,0	12	11	2	008 0600
6,0	10,0	15	8,5	2	008 0609
8,0	11,0	16	7	2	008 0811
8,0	11,0	16	13	2	008 0800
8,0	12,0	16	6	2	008 0809
8,0	14,0	20	10	2	008 0810
10,0	12,0	16	6	2	008 1010
10,0	13,0	18	8	2	008 1014
10,0	13,0	18	15	2	008 1000
10,0	13,0	21	16	3	008 1016
10,0	14,0	20	10	2	008 1011
10,0	16,0	21	10	2	008 1012
12,0	14,0	20	10	2	008 1206
12,0	16,0	21	10	2	008 1207
12,0	16,0	21	19	2	008 1200
14,0	18,0	28	21	3	008 1400
16,0	20,0	28	15,5	2,5	008 1603
16,0	20,0	28	22	2,5	008 1600
16,0	22,0	30	15	2,5	008 1604
18,0	22,0	30	25	2,5	008 1800
18,5	20,0	23,5	7,5	1,4	008 1803
20,0	24,0	30	15	2	008 2002
20,0	24,0	30	26	2	008 2000
20,0	25,0	30	15	2	008 2003
20,0	26,0	30	15	2	008 2004
24,0	30,0	37	30	2,5	008 2400
25,0	30,0	37	30	2,5	008 2500
28,0	33,0	40	33	2,5	008 2800
30,0	35,0	42	35	2,5	008 3000
32,0	38,0	45	38	3	008 3200
40,0	46,0	55	46	3	008 4000
50,0	56,0	67	50	3,5	008 5000
60,0	68,0	81	50	4	008 6000

Se også neste side

Uten flens

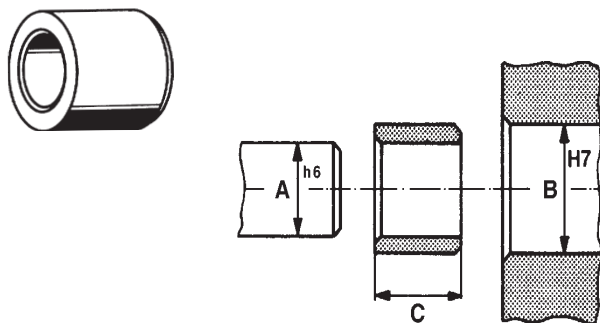

A	B	C	TYPE NR.
8,0	12,0	10	103 0812
8,0	14,0	10	103 0814
10,0	12,0	10	103 1012
10,0	14,0	10	103 1014
10,0	16,0	10	103 1016
12,0	14,0	10	103 1214
12,0	16,0	10	103 1216
12,0	18,0	14	103 1218
15,0	20,0	15	103 1520
15,0	22,0	15	103 1522
15,0	25,0	15	103 1525
16,0	20,0	15	103 1620
16,0	22,0	15	103 1622
16,0	24,0	15	103 1624
20,0	24,0	15	103 2024
20,0	25,0	15	103 2025
20,0	26,0	20	103 2026
20,0	28,0	20	103 2028

Glidelager

Materiale: Nylon 6.6 med karbonfiber og PTFE

Forbedrede mekaniske egenskaper:

- Redusert slitasje
- Lav friksjon
(frikksjonskoeffisient 0,11 (statisk))
- God varmeldningsevne.
- Egnet for større radielle krefter
- Høyere hastighet. (Max 0,9m/s)

Med flens

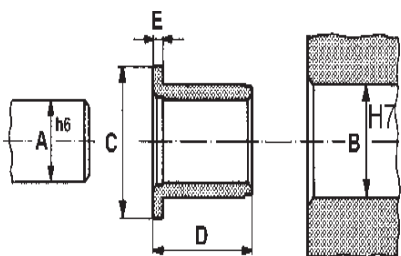

Etter montering er lagerklaringen ca 1% av akseldiameteren

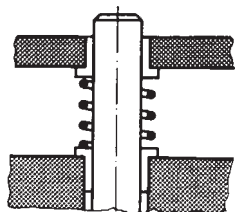
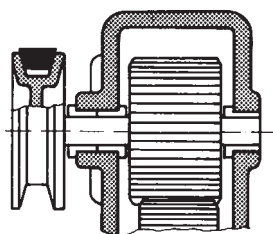



A	B	C	D	E	TYPE NR.
6,0	8,0	12,0	4,0	1,0	008 7050
6,0	8,0	12,0	6,0	1,0	008 7070
6,0	8,0	12,0	8,0	1,0	008 7090
6,0	8,0	12,0	10,0	1,0	008 7110
8,0	10,0	15,0	5,5	1,0	008 7130
8,0	10,0	15,0	7,5	1,0	008 7150
8,0	10,0	15,0	10,0	1,0	008 7170
8,0	10,0	15,0	15,0	1,0	008 7190
10,0	12,0	18,0	6,0	1,0	008 7210
10,0	12,0	18,0	9,0	1,0	008 7230
10,0	12,0	18,0	12,0	1,0	008 7250
10,0	12,0	18,0	15,0	1,0	008 7270
12,0	14,0	20,0	9,0	1,0	008 7290
12,0	14,0	20,0	12,0	1,0	008 7310
12,0	14,0	20,0	15,0	1,0	008 7330
12,0	14,0	20,0	20,0	1,0	008 7350
14,0	16,0	22,0	12,0	1,0	008 7370
14,0	16,0	22,0	17,0	1,0	008 7390
15,0	17,0	23,0	9,0	1,0	008 7410
15,0	17,0	23,0	12,0	1,0	008 7430
15,0	17,0	23,0	17,0	1,0	008 7450
16,0	18,0	24,0	12,0	1,0	008 7470
16,0	18,0	24,0	17,0	1,0	008 7490
18,0	20,0	26,0	12,0	1,0	008 7510
18,0	20,0	26,0	17,0	1,0	008 7530
20,0	23,0	30,0	11,5	1,5	008 7550
20,0	23,0	30,0	16,5	1,5	008 7570
20,0	23,0	30,0	21,5	1,5	008 7590
25,0	28,0	35,0	16,5	1,5	008 7610
25,0	28,0	35,0	21,5	1,5	008 7630
25,0	28,0	35,0	30,0	1,5	008 7650
30,0	34,0	42,0	16,0	2,0	008 7670
30,0	34,0	42,0	26,0	2,0	008 7690
30,0	34,0	42,0	37,0	2,0	008 7710
32,0	36,0	45,0	16,0	2,0	008 7730
32,0	36,0	45,0	26,0	2,0	008 7750
35,0	39,0	47,0	16,0	2,0	008 7770
35,0	39,0	47,0	26,0	2,0	008 7790
40,0	44,0	52,0	30,0	2,0	008 7810
40,0	44,0	52,0	40,0	2,0	008 7830
45,0	50,0	58,0	30,0	2,0	008 7850
45,0	50,0	58,0	50,0	2,0	008 7870

D

Håndtak

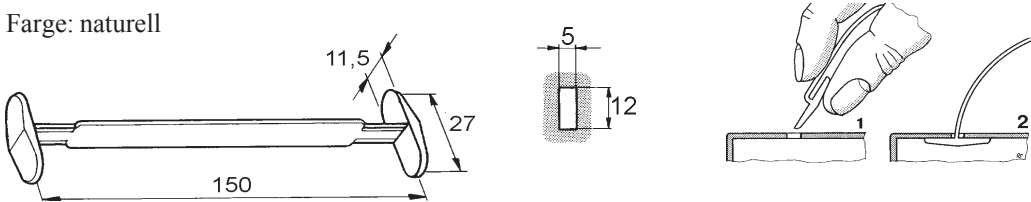
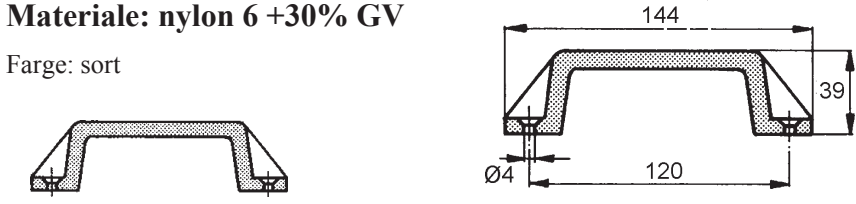
Materiale: Polyetylen og nylon 6 +30% glassfiber (GV)

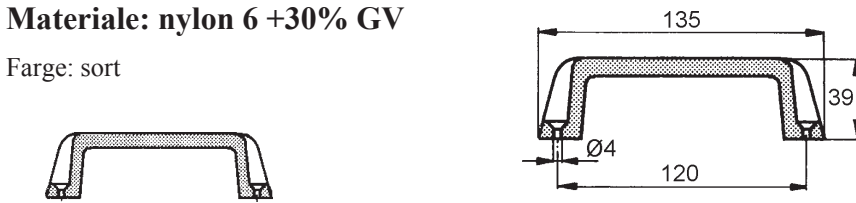
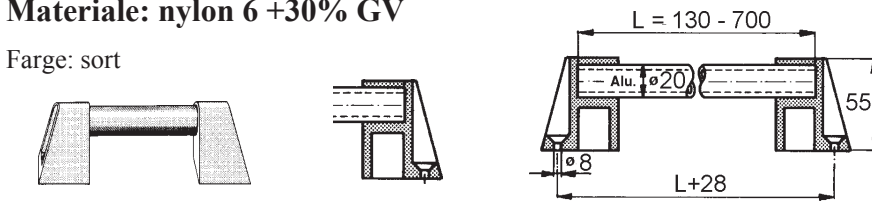
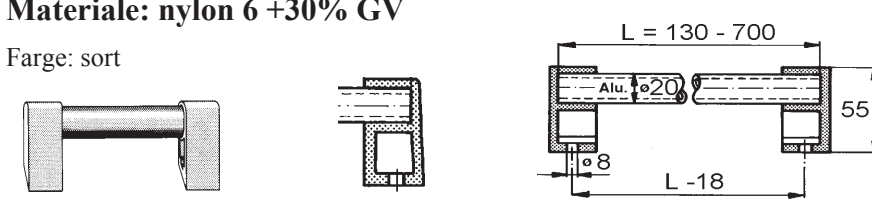
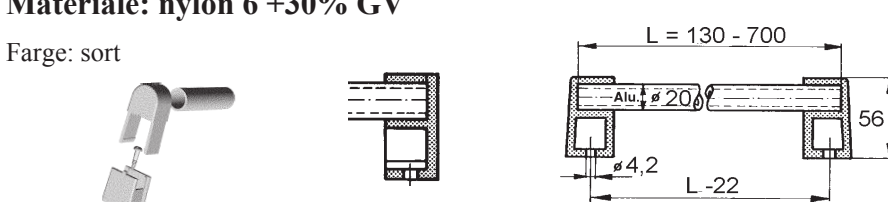
<p>Materiale: polyetylen Farge: naturell</p> 	<p>TYPE NR. 157 0150</p>
<p>Materiale: nylon 6 +30% GV Farge: sort</p> 	<p>109 0001</p>
<p>Materiale: nylon 6 +30% GV Farge: sort</p> 	<p>109 0002</p>
<p>Materiale: nylon 6 +30% GV Farge: sort</p> 	<p>109 0003</p>
<p>Materiale: nylon 6 +30% GV Farge: sort</p> 	<p>110 0001</p>
<p>Materiale: nylon 6 +30% GV Farge: sort</p> 	<p>110 0002</p>
<p>Materiale: nylon 6 +30% GV Farge: sort</p> 	<p>110 0003</p>

D

Kulehåndtak

Materiale: Bakelitt

Med gjenget hull

Farge: sort

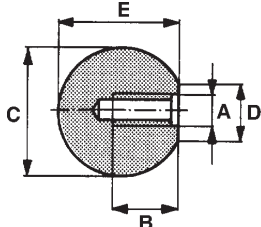

	A	B	C	D	E	TYPE NR.
M4	7	16	8	15		107 0416
M5	9	20	12	18		107 0520
M6	11	25	15	22,5		107 0625
M8	14	32	18	29		107 0832
M10	18	40	22	37		107 1040
M12	21	50	28	46		107 1250
M14	21	50	28	46		107 1450
M16	21	50	28	46		107 1650

Justeringsfot

Materiale: Fot: Polypropylen / Skruer: Stål, galvanisert

Farge: sort

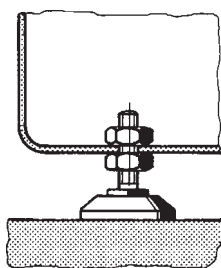
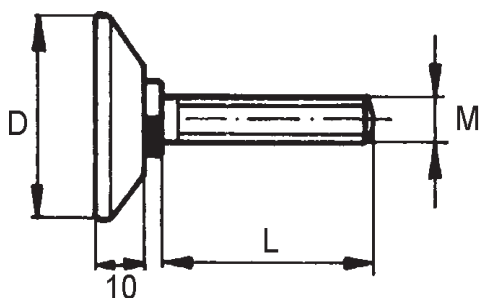

	D	M	L	TYPE NR.
	38	M8	16	148 3801
	38	M8	20	148 3802
	38	M8	30	148 3803
	38	M8	40	148 3804
	38	M8	50	148 3805
	38	M8	60	148 3806
	38	M8	70	148 3807
	38	M8	80	148 3808
	38	M8	90	148 3809
	38	M8	100	148 3810
	38	M10	16	148 3001
	38	M10	20	148 3002
	38	M10	30	148 3003
	38	M10	40	148 3004
	38	M10	50	148 3005
	38	M10	60	148 3006
	38	M10	70	148 3007
	38	M10	80	148 3008
	38	M10	90	148 3009
	38	M10	100	148 3010
	48	M8	16	148 4801
	48	M8	20	148 4802
	48	M8	30	148 4803
	48	M8	40	148 4804
	48	M8	50	148 4805
	48	M8	60	148 4806
	48	M8	70	148 4807
	48	M8	80	148 4808
	48	M8	90	148 4809
	48	M8	100	148 4810
	48	M10	16	148 4001
	48	M10	20	148 4002
	48	M10	30	148 4003
	48	M10	40	148 4004
	48	M10	50	148 4005
	48	M10	60	148 4006
	48	M10	70	148 4007
	48	M10	80	148 4008
	48	M10	90	148 4009
	48	M10	100	148 4010

Nagler

Materiale: Polyamid 6

Snip & Snap

2 stk til et festepunkt

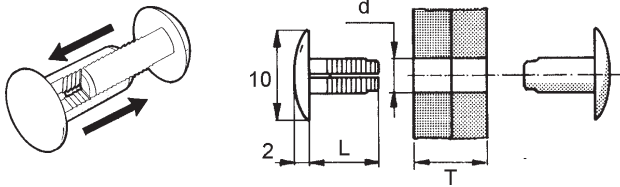

d	L	T	TYPE NR.
5,5	5,4	5,7 - 7,3	096 0655
5,5	8,5	8,9 - 12,9	096 0955
5,5	12,4	12,8 - 20,5	096 1355
5,5	19,8	20,2 - 34,4	096 2055
7,0 - 7,2	5,4	5,7 - 7,3	096 0610
7,0 - 7,2	8,5	8,9 - 12,9	096 0910
7,0 - 7,2	12,4	12,8 - 20,5	096 1310
7,0 - 7,2	19,8	20,2 - 34,4	096 2010

Farge: naturell 000

sort 599

grå 002

gul 132

blå 087

rød 124

Bestillingseks: 096 1310 000

Låseskive for nagle

$\geq D$	$\emptyset C$	B	$\emptyset A$	TYPE NR.
0,9	5,5	2	10	096 0010

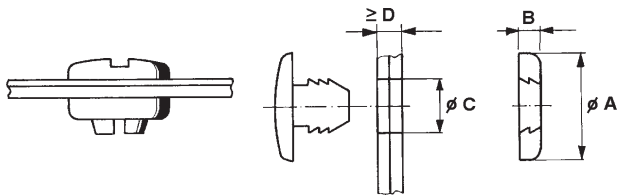

Farge: naturell 000

sort 599

grå 002

gul 132

blå 087

rød 124

Bestillingseks: 096 0010 000

Underlagsskive for nagle

A	B	TYPE NR.
18,2	2,1	096 0018

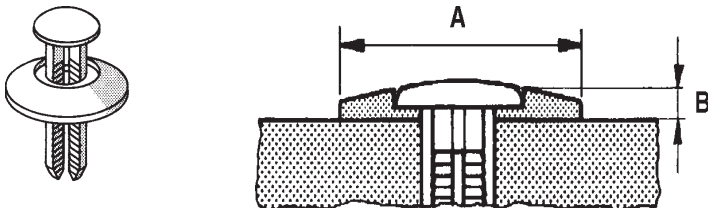

Farge: naturell 000

sort 599

grå 002

gul 132

blå 087

rød 124

Bestillingseks: 096 0018 000

Nagler

Materiale: POM og Polyamid 6.6

Materiale: Polyamid 6.6

Farge: naturell 000
sort 599

A	B	C	D	E	TYPE NR.
14	15	2	3 - 11	5,8	092 0001
16	19	2	3 - 15	5,8	092 0002
18	23	2	3 - 19	7,0	092 0004

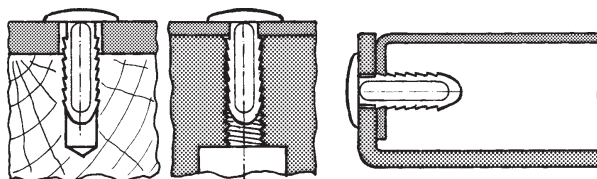
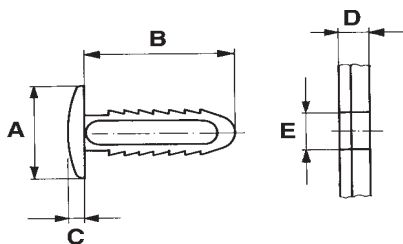

Materiale: POM

Farge: naturell 000
sort 599

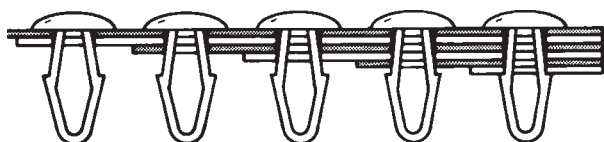
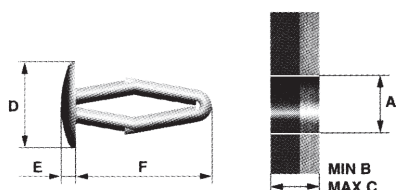

A	B	C	D	E	F	Type nr.
3,2	1,0	4,5	8	1,5	13	137 0008
3,3	1,0	4,5	8	1,5	13	137 0010
3,9	1,0	5,0	9	1,6	14	137 0020
4,7	1,0	5,5	10	1,7	15	137 0030
4,7	1,0	5,5	10	3,0	15	137 0031
6,4	1,5	6,5	12	2,0	17	137 0040
7,8	1,5	7,0	14	2,4	19	137 0050
5,5	6,0	9,0	12	2,0	18	137 0060

Materiale: Polyamid 6.6

Farge: naturell - ufarget 000
sort 699 eller 599
hvit 500

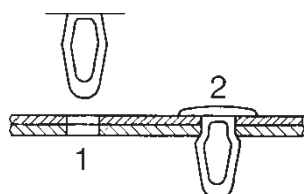
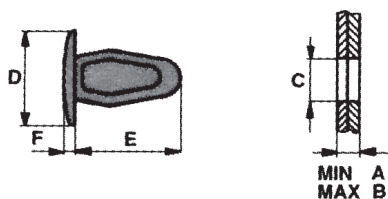

A	B	C	D	E	F	Type nr.
0,8	3,6	2,8	7,8	12	1,2	091 0000
2,4	5,8	3,5	7,6	13	1,1	091 0001
0,9	4,0	3,5	10,3	11	2,5	091 0002
0,9	4,0	3,5	10,3	11	4,8	091 0003
0,8	4,0	4,8	9,5	11	1,5	091 0006
1,5	3,5	5,0	9,5	11	1,6	091 0004
3,0	6,0	5,0	13,8	14,4	2,2	091 0007
0,5	3,0	5,0	13,5	14,4	2,6	091 0010
6,0	8,5	5,8	15	18	3,0	091 0012
3,0	7,0	6,5	14	19	2,5	091 0011
0,8	5,0	6,6	12,7	14,5	1,7	091 0013
2,0	5,5	7,2	14,3	17	2,0	091 0015
3,0	9,0	9,4	20	24	2,6	091 0016

Nagler

Materiale: Nylon 66

Farge: naturell 000
sort 699

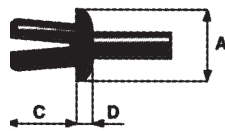
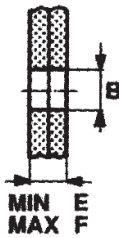
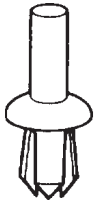

	A	B	C	D	E	F	Type nr.
5,0	3,0	5,7	1,3	1,0	4,0	093 0110	
6,0	3,5	6,8	1,3	1,0	5,0	093 0120	
6,5	4,0	7,9	1,5	1,5	6,0	093 0130	
7,1	4,8	11	1,2	4,0	8,7	093 0008	
8,5	5,0	9,2	1,8	1,5	7,0	093 0140	
10,0	6,0	10,5	2,2	2,0	8,0	093 0150	
11,0	6,0	10	2,0	3,0	7,0	093 0024	
12,0	7,0	11,8	2,6	2,5	9,0	093 0160	
17,0	7,1	17,5	2,5	4,0	12,0	093 0018	
13,5	8,0	13,0	3,0	3,0	10,0	093 0170	
4,8	3,3	5	1,3	0,5	3,5	093 0001	
7,7	3,6	7	2,0	2,0	5,5	093 0002	
6,5	4,0	8	1,5	4,0	6,5	093 0004	
7,5	4,0	8	1,5	4,0	6,5	093 0005	
6,0	4,1	6	1,5	0,6	4,5	093 0022	
8,7	4,8	7,4	2,5	1,6	4,7	093 0010	
7,1	5,0	7,4	2,0	1,5	5,0	093 0007	
9,7	5,0	11	2,0	3,0	7,0	093 0014	
11,0	6,4	12	2,0	4,0	9,5	093 0026	

D

Monteringsverktøy

Praktisk håndverktøy for montering av nagler serie 093.
Leveres i 10 forskjellige størrelser tilpasset nagledimensjonen.

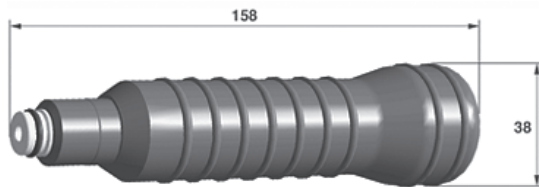

Bruk verktøy 112 0110 til nagle 093 0110 osv.
Senterpinnen blir montert sikkert.
Hindrer at den faller ut av produktet og gjør monteringsprosessen raskere.

Nagle type	Verktøy type
093 0110	112 0110
093 0120	112 0120
093 0130	112 0130
093 0008	112 0008
093 0140	112 0140
093 0150	112 0150
093 0024	112 0024
093 0160	112 0160
093 0018	112 0018
093 0170	112 0170

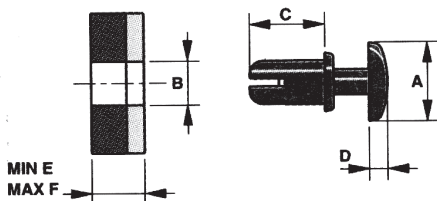
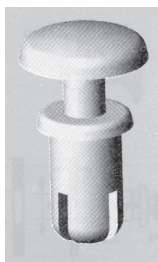

Farge: naturell 000
sort 699

	A	B	C	D	E	F	Type nr.
6,2	3,1	3,7	1,6	1,0	2,0	094 0110	
6,2	3,1	4,5	1,6	2,0	3,0	094 0120	
6,2	3,1	5,5	1,6	3,0	4,0	094 0130	
6,2	3,6	3,7	1,6	1,2	2,1	094 0210	
6,2	3,6	4,6	1,6	2,2	3,1	094 0220	
6,2	3,6	5,0	1,6	2,7	3,6	094 0230	
6,2	3,6	5,5	1,6	3,2	4,1	094 0240	
6,2	3,6	6,0	1,6	3,7	4,6	094 0250	
6,2	3,6	7,1	1,6	4,7	5,6	094 0260	
7,8	4,1	5,0	1,8	2,5	3,5	094 0310	
7,8	4,1	6,0	1,8	3,5	4,5	094 0320	
8,0	4,1	7,0	1,8	4,5	5,5	094 0330	
8,0	4,1	8,0	1,8	5,5	6,5	094 0340	
8,0	4,1	10,0	2,2	7,5	8,5	094 0350	
9,0	5,1	4,5	2,2	1,5	2,5	094 0410	
9,0	5,1	5,5	2,2	2,5	3,5	094 0420	
9,0	5,1	6,5	2,2	3,5	4,5	094 0430	
9,0	5,1	7,5	2,2	4,5	5,5	094 0440	
9,0	5,1	8,5	2,2	5,5	6,5	094 0450	
12,0	6,1	6,0	2,5	2,5	4,0	094 0510	
12,0	6,1	8,0	3,0	4,0	5,5	094 0520	

Nagler

Utløsbar nagle

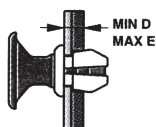
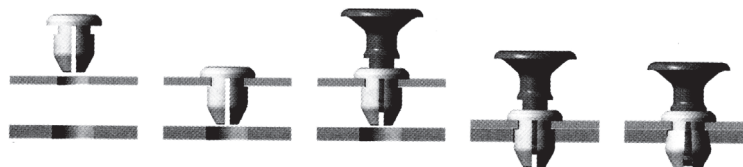

Egner seg for rask montering og demontering av f.eks. deksler.
 Monteres ved å trykke pinnen (F1) inn i naglen (F2).
 Demonteres ved å trekke ut pinnen (F1).
 Levetid mer enn 30.000 x

Materiale:
 Pinne - Polyamid 6
 Nagle - Polykarbonat
 Farge: Sort eller

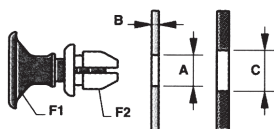

A	B	C	D	E	F	Type nr.
7,6	1,5	8	1,9	4,2	F1	095 0010
7,6	1,5	8	1,9	4,2	F2	095 0020
7,6	2,5	8	3	5,2	F1	095 0030
7,6	2,5	8	3	5,2	F2	095 0040

Skruenagle

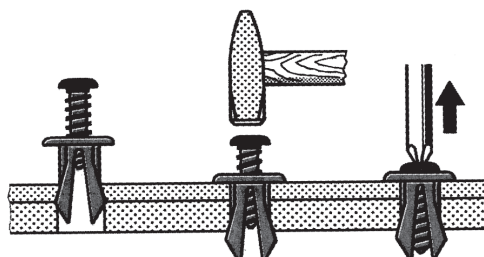
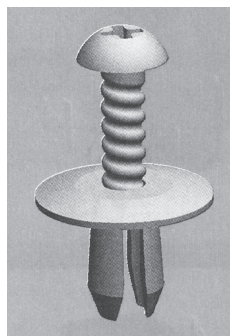

Skruenagle som lett monteres og løsnes.
 Kan ofte brukes på nytt.

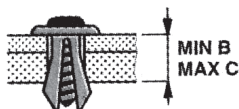
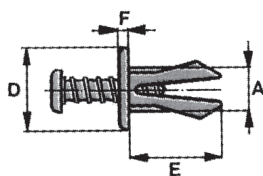

Materiale: Polyamid 6.6
 Farge: Sort.

A	B	C	D	E	F	Type nr.
5	2	7	12,5	9,6	1,2	113 1050
6	2	8	15	10,7	1,3	113 1060
7	3	9	17,5	12,1	1,4	113 1070
8	3	10	20	13,5	1,5	113 1080
5	4	7	12	11	1,5	113 0001
6	4	7	16	11	1,5	113 0002
8	3	10	20	14	1,5	113 0003

Slangeklemmer

Materiale: Nylon 66

Farge: sort

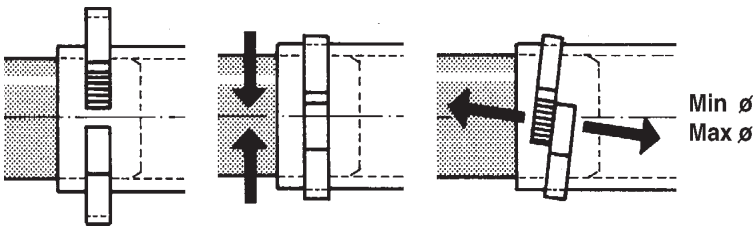
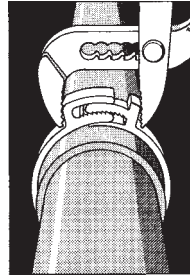
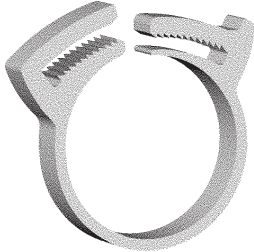

Ø	TYPE NR.
6,6 - 8,0	135 0101
8,0 - 9,2	135 0102
9,2 - 10,5	135 0103
10,2 - 12,0	135 0104
12,0 - 13,5	135 0105
12,8 - 15,0	135 0106
15,0 - 17,2	135 0107
17,0 - 18,5	135 0108
18,2 - 20,5	135 0109
20,5 - 23,0	135 0110
22,0 - 25,0	135 0111
25,0 - 28,0	135 0112
27,0 - 30,0	135 0113
29,5 - 32,5	135 0114
32,5 - 35,5	135 0115
35,0 - 38,5	135 0116
38,0 - 41,5	135 0117
41,0 - 44,5	135 0118
44,0 - 47,5	135 0119
47,0 - 50,5	135 0120
50,0 - 53,5	135 0121
53,0 - 57,0	135 0122
56,5 - 60,5	135 0123
60,0 - 65,0	135 0124
66,0 - 70,0	135 0125
70,0 - 75,0	135 0126
76,0 - 80,0	135 0127
80,0 - 85,0	135 0128

Rørfester

Materiale: Nylon 6

Farge: grå

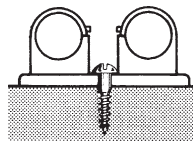
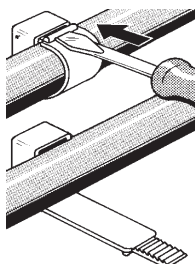

012 0100*

D	TYPE NR.
12 -13-14	012 0120
15-16-17	012 0150
	012 0100*

Hetter/plugger

Materiale: Polyetylen, myk

Farge: rød

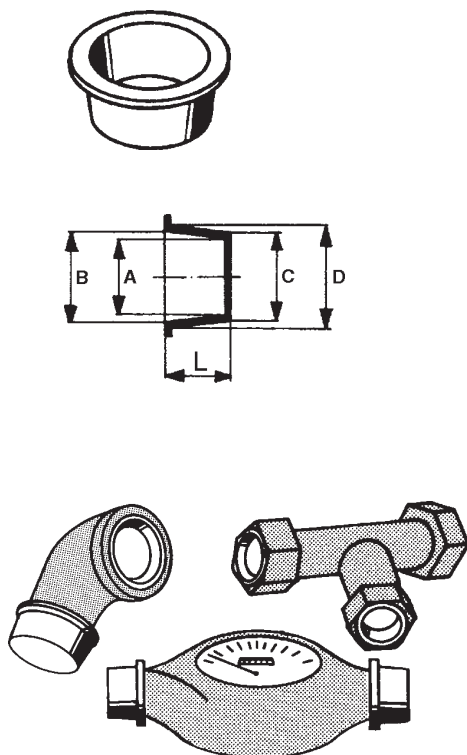

	A	B	C	D	L	TYPE NR.
1,5	3,0	3,0	3,0	4,5	10,3	004 0030
2,7	4,2	4,0	4,0	5,5	10,0	004 0040
4,4	6,0	6,0	6,0	7,5	10,3	004 0060
6,2	7,5	7,5	7,5	9,3	9,6	004 0075
7,6	9,2	9,5	9,5	10,7	10,3	004 0095
9,0	10,5	10,5	10,5	12,0	9,8	004 0105
10,1	12,2	11,8	11,8	13,3	11,5	004 0118
11,8	14,3	13,3	13,3	15,5	12,8	004 0133
14,0	16,2	16,0	16,0	17,5	12,5	004 0160
14,3	15,4	16,4	16,4	17,2	5,6	004 0164
15,2	18,0	16,7	16,7	19,2	12,7	004 0167
17,2	20,1	18,6	18,6	21,1	14,8	004 0186
18,6	20,7	20,3	20,3	22,5	16,7	004 0203
19,2	21,5	20,7	20,7	23,0	14,7	004 0207
20,8	23,0	22,5	22,5	24,2	14,7	004 0225
23,0	25,5	25,0	25,0	27,5	15,2	004 0250
24,4	27,3	26,2	26,2	28,5	16,4	004 0262
25,4	29,5	27,2	27,2	30,1	16,4	004 0272
28,5	32,1	30,7	30,7	33,6	16,4	004 0307
30,3	33,5	31,8	31,8	34,5	17,2	004 0318
31,4	35,0	33,4	33,4	36,8	18,3	004 0334
35,8	39,0	37,8	37,8	41,0	18,3	004 0378
38,3	41,5	39,8	39,8	42,8	20,3	004 0398
40,4	43,8	42,0	42,0	45,0	20,3	004 0420
42,5	45,5	44,2	44,2	47,0	20,3	004 0442
43,4	47,5	45,2	45,2	49,0	25,6	004 0452
46,0	51,5	48,2	48,2	52,5	22,5	004 0482
52,0	57,5	54,0	54,0	58,0	22,3	004 0540
57,0	59,5	58,5	58,5	61,0	15,0	004 0585
57,6	63,0	59,1	59,1	64,0	24,2	004 0591
59,2	64,5	61,0	61,0	65,0	30,0	004 0610
69,0	73,0	71,3	71,3	74,0	25,0	004 0713
72,2	76,0	74,0	74,0	77,8	25,0	004 0740
77,2	80,2	79,0	79,0	82,0	15,0	004 0790
81,5	85,5	83,5	83,5	87,0	24,8	004 0835
87,0	91,0	89,0	89,0	93,0	25,0	004 0890
97,0	101,0	99,0	99,0	103,0	24,5	004 0990
106,8	111,0	109,0	109,0	113,2	24,5	004 1090
121,8	126,0	124,0	124,0	128,2	24,5	004 1240
144,8	149,0	146,0	146,0	151,0	24,5	004 1460
156,2	161,0	159,0	159,0	163,8	24,5	004 1590

Farge: sort

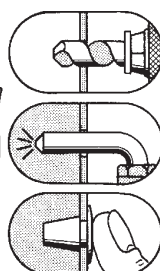
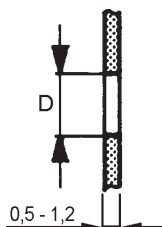
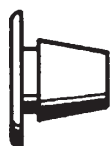

D	TYPE NR.
8	010 0080
10	010 0100

Plugger

Materiale: Myk Polyetylen,

Farge: naturell

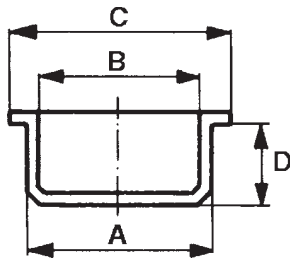

A	B	C	D	TYPE NR.
4,2	2,4	8,8	4,4	061 0042
5,3	4,1	8,3	5	061 0053
6,3	5,2	9,3	5	061 0063
7,2	6,1	10,2	6,3	061 0072
7,7	6,1	10,7	6,3	061 0077
8,1	7	11,1	6,3	061 0081
8,5	7	11,5	6,3	061 0085
9,1	7,9	12,9	6,4	061 0091
9,1	7,9	12,9	10,0	061 0101
10,4	9,3	14,3	6,9	061 0104
11,2	10,3	15,2	6,9	061 0112
12,1	11	15,9	7	061 0121
12,5	11	16,4	7	061 0125
13,0	11,9	16,9	7,7	061 0130
14,5	13,3	18,4	7,5	061 0145
15,3	13,8	19,3	11,3	061 0153
15,5	14,4	19,1	7,7	061 0155
16,0	14,9	19,6	7,7	061 0160
17,1	16,1	20,9	7,7	061 0171
17,8	16,7	21,4	7,7	061 0178
18,2	16,7	21,8	7,7	061 0182
19,6	18,5	23,3	8,3	061 0196
20,7	19,6	24,7	8,5	061 0207
21,7	20,6	25,7	8,5	061 0217
22,3	20,6	26,2	8,5	061 0223
24,5	23,4	28,6	8,5	061 0245
25,1	23,9	28,8	8,5	061 0251
27,2	26	31,5	8,5	061 0272
30,0	28,8	34	8,5	061 0300
31,1	29,9	35	8,5	061 0311
31,8	30,2	35,8	8,5	061 0318
36,0	34,4	40,2	8,5	061 0360
39,1	37,5	43,1	8,5	061 0391
40,9	38,3	52,7	9,6	061 0405
43,0	41,4	46,8	4	061 0426
46,5	44,5	53,7	8,5	061 0461
51,1	49,5	60	8,7	061 0511
58,2	56,5	66,5	8,7	061 0582
74,3	72,5	82,5	8,7	061 0736
86,6	84,6	98,6	9,5	061 0866
101,8	99,8	113,8	9,5	061 1018

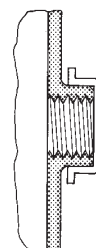
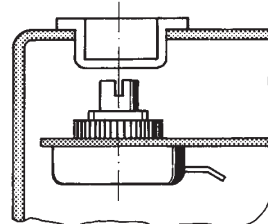
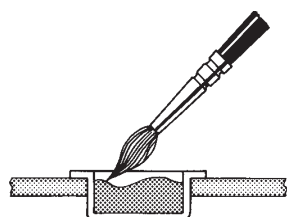
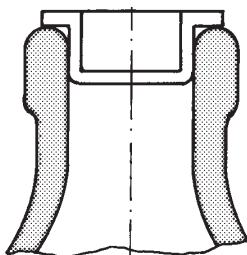

Plugger

Materiale: Myk Polyetylen

Farge: naturell

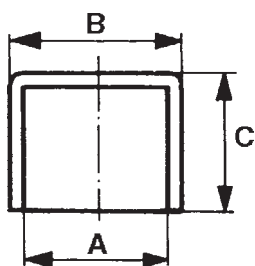

A	B	C	TYPE NR.
5,7	7,4	12	062 0060
7,8	9,4	14	062 0080
9,8	11,3	11	062 0100
10,0	11,8	8	062 0102
10,3	12,0	8	062 0105
11,7	13,7	12,5	062 0120
12,7	14,9	13,5	062 0130
13,4	15,0	13,5	062 0135
15,7	17,0	15	062 0160
16,7	18,8	14,5	062 0170
17,7	19,8	14,5	062 0180
19,7	21,4	14	062 0200
20,6	22,9	15	062 0207
21,2	23,8	16	062 0213
23,6	25,6	18,5	062 0240
25,7	27,7	17,5	062 0260
26,3	28,5	18,5	062 0273
29,5	31,5	18,5	062 0300
32,8	35,8	22,5	062 0343
32,8	35,2	45	062 0344
34,0	36,0	26	062 0348
35,0	37,4	14	062 0360
36,7	39,7	20	062 0380
40,8	43,5	28	062 0421
47,6	50,5	29,5	062 0484
50,8	53,0	30,5	062 0510
51,6	53,8	16	062 0520
52,5	55,7	29,5	062 0530
56,3	59,7	19	062 0573
59,5	62,0	30	062 0606
69,8	74,0	25,5	062 0700
75,5	79,0	36	062 0716
76,0	78,5	18	062 0765
79,5	84,0	25,5	062 0800
87,0	90,0	35	062 0892
101,8	104,0	24	062 1018

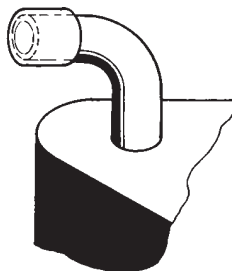
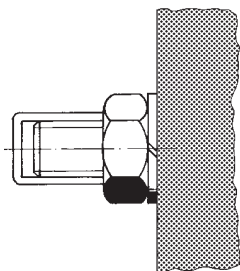

D

Plugger

Materiale: Myk Polyetylen,

Farge: naturell

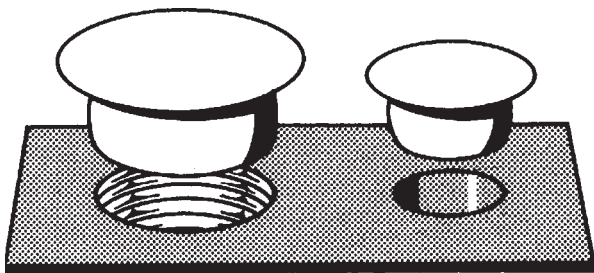
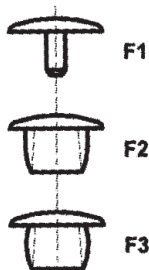
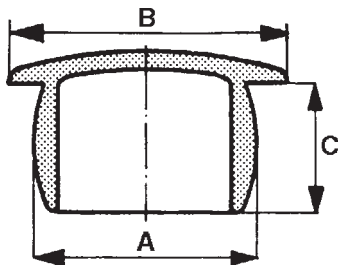
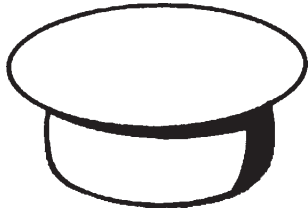

A	B	C	F	TYPE NR.
2,1	3,5	7	F1	055 0022
2,6	12	4	F1	055 0025
2,7	12	6	F1	055 0026
3,3	12	6	F1	055 0032
4,4	9	5,2	F2	055 0044
4,6	7	5	F2	055 0047
5,1	11	6	F2	055 0052
5,4	12	7,5	F2	055 0054
6	11	7	F2	055 0060
6,6	7,5	5	F2	055 0066
7,2	11	6,5	F2	055 0070
7,3	11	6	F2	055 0073
7,5	11	4,5	F2	055 0075
8	12	7,5	F2	055 0080
8,5	12	4	F2	055 0084
8,5	12	8	F2	055 0085
8,8	11,5	8	F2	055 0088
9,3	12	9	F3	055 0093
10	15	9	F2	055 0100
10	12	4	F2	055 0101
10,7	14,8	9	F3	055 0107
11,9	14,8	8	F3	055 0119
12,8	17,5	9	F3	055 0125
13,2	17,5	8	F3	055 0132
13,9	19,5	9	F3	055 0136
14,9	18,5	9	F3	055 0143
15,4	19	8,5	F3	055 0154
15,9	19	8,5	F3	055 0157
17	19,5	9	F3	055 0168
17,4	23	9,5	F2	055 0172
18,8	21,5	9	F2	055 0183
19,6	25,5	9,3	F2	055 0196
20,5	25,2	9	F3	055 0200
21	25,6	12,6	F2	055 0210
22,6	29	9	F3	055 0223
23	27,4	19,3	F2	055 0230
24	27	12,8	F2	055 0240
25	32	13	F3	055 0245
24,8	31,5	6	F2	055 0255
26	31,5	12,3	F3	055 0260
26	28,5	11,8	F2	055 0261
27	29,6	15	F2	055 0272
28,6	34	15	F3	055 0286
31,2	38	13	F3	055 0312
33,5	41	12	F3	055 0335
34	40	20	F1	055 0340
35,5	46,5	15	F2	055 0356
36,5	46,5	18	F3	055 0365
39,5	46	16	F3	055 0395
42,2	44,5	13	F3	055 0420
43,3	50,5	15	F3	055 0433
45,3	51	16	F3	055 0455

Fortsetter neste side

Plugger

Materiale: Myk Polyetylen

Farge: naturell

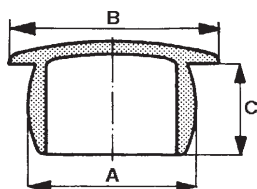
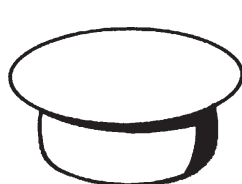

A	B	C	F	TYPE NR.
45,8	51	16	F3	055 0458
50,5	57	14	F3	055 0505
52,5	60	14	F3	055 0520
55,3	59,5	19,5	F2	055 0553
55,5	59	16	F3	055 0555
58	63	19,5	F3	055 0580
61	74	19	F3	055 0615
70	80	18	F3	055 0700
85	93,5	18	F3	055 0850
110,5	130	18	F2	055 1100

Farge: sort eller hvit
Oppgis ved bestilling

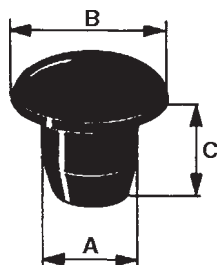

A	B	C	TYPE NR.
4,4	9	5,2	054 0449
4,6	7	5,0	054 0477
5,4	12	7,5	054 0542
5,4	15	7,5	054 0545
6,0	11	7,0	054 0601
6,0	12	7,0	054 0602
6,0	15	7,0	054 0605
7,2	11	6,5	054 0701
7,2	12	6,5	054 0702
7,2	15	6,5	054 0705
8,0	12	7,5	054 0802
8,0	15	7,5	054 0805
8,5	12	8	054 0852
8,5	15	8	054 0855
10,0	12	9	054 1002
10,0	12	4	054 1003
10,0	15	9	054 1005
11,9	17,5	8,5	054 1198
15,4	19	8,5	054 1549

D

Ventilasjonsdeksler

Materiale: Nylon 6

Farge: Grå, Sort eller Hvit
Oppgis ved bestilling

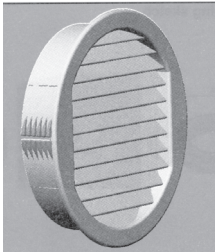

A	B	C	F	TYPE NR.
30,0	25,0	10	F1	123 1025
30,5	25,4	10	F2	123 0025
50,0	43,0	12	F1	123 1043
48,0	43,0	4	F3	123 0043
80,0	70,0	15,5	F1	123 1070

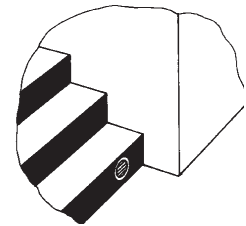
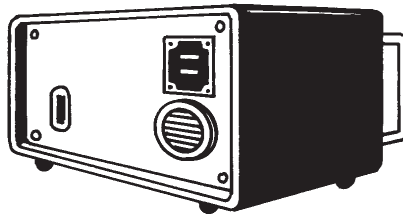
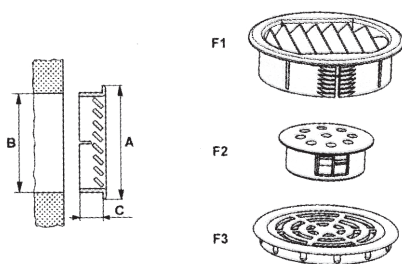

Lamellplugger

Materiale: Polyetylen

For kvadratiske rør

Farge: sort, grå eller hvit

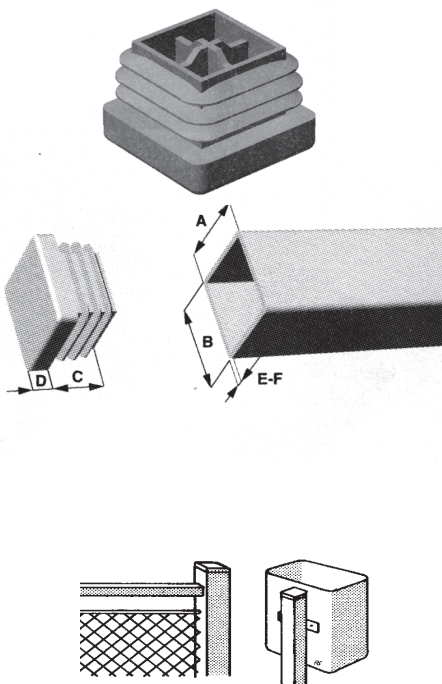

	A	B	C	D	E	F	TYPE NR.
10	10	10	11,5	4	1,5	2,0	056 0100
12	12	12	7	2	1,0	2,0	056 0120
13	13	13	11,5	4	1,5	2,0	056 0130
15	15	15	13	3	1,0	2,0	056 0150
16	16	16	11,5	5	1,5	2,0	056 0160
18	18	18	12	5	1,0	2,0	056 0180
20	20	20	11,5	5	1,5	2,0	056 0200
22	22	22	11,5	5	1,0	3,5	056 0220
25	25	25	12	6	1,5	2,0	056 0250
30	30	30	12	6	1,5	2,0	056 0300
32	32	32	11,5	5	1	3,5	056 0320
35	35	35	14,5	5	1,0	3,0	056 0350
40	40	40	14,5	5	1,5	3,0	056 0400
45	45	45	14,5	5	1,0	3,0	056 0450
50	50	50	20	5	1,5	4,0	056 0500
55	55	55	14,5	5	2	4	056 0550
60	60	60	24	5	1,5	3,5	056 0600
70	70	70	18,5	5	2	4	056 0700
80	80	80	24	8	3,0	5,0	056 0800
90	90	90	25	7	3,5	5,0	056 0900
100	100	100	24	7	2,0	4,0	056 1000
110	110	110	24,5	6	3	5	056 1100
120	120	120	25	5	2,5	5	056 1200
140	140	140	35	6	4	7	056 1400

For rektangulære rør

Farge: sort, grå eller hvit

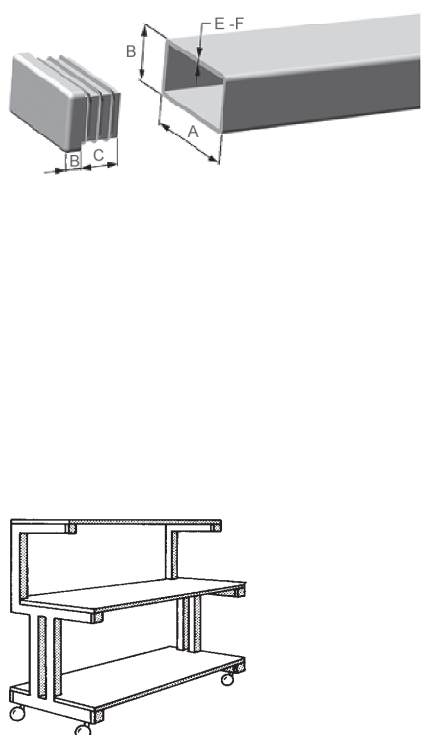

20	10	10	11,5	3	1,0	2,0	057 2010
20	12	12	9,5	2	1,0	1,5	057 2012
20	15	15	11,5	5	1,0	1,5	057 2015
20	16	16	11,5	5	1,5	2,0	057 2016
25	10	10	11,5	4	1,5	2,0	057 2510
25	15	15	11,5	5	1,0	2,5	057 2515
25	20	20	11,5	5	1,5	2,0	057 2520
30	10	10	11,5	4	1,5	2,0	057 3010
30	15	15	12	5	1,0	2,0	057 3015
30	20	20	12	6	1,0	2,0	057 3020
30	25	25	13,5	5	1,5	1,5	057 3025
35	15	15	11,5	5	1	3	057 3515
35	20	20	11,5	5	1,5	2,5	057 3520
35	25	25	11,5	5	1,5	2,0	057 3525
40	10	10	11	5	1	3	057 4010
40	15	15	11,7	5	1	3	057 4015
40	20	20	14,5	6	1,5	2,0	057 4020
40	25	25	11,5	5	1,0	3,0	057 4025
40	30	30	11,5	5	1,0	3,0	057 4030
45	20	20	11,5	5	1,5	2,0	057 4520
45	25	25	11,5	5	1,5	2,0	057 4525
50	10	10	11,5	3,5	0,75	2	057 5010
50	20	20	14,5	5	1,0	3,0	057 5020
50	25	25	14,5	5	1,0	3,0	057 5025
50	30	30	14,5	5	1,0	3,0	057 5030
50	34	34	14,5	5	1	5	057 5034
50	40	40	12	5	1	3	057 5040

Fortsetter neste side

Lamellplugger

Materiale: Polyetylen

For rektangulære rør

Farge: sort, grå eller hvit

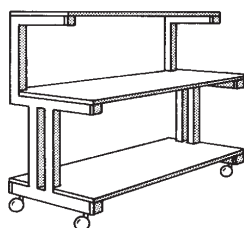
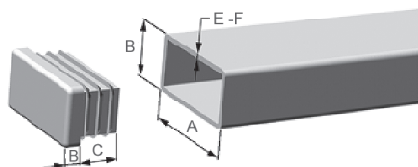

	A	B	C	D	E	F	TYPE NR.
	55	34	14,5	5	1,5	4	057 5534
	60	20	14,5	5	1,5	2,0	057 6020
	60	25	14,5	5	1,0	2,5	057 6025
	60	30	14,5	5	1,0	2,5	057 6030
	60	40	14,5	5	1,0	3,0	057 6040
	60	50	14,5	5	1,5	3,5	057 6050
	70	20	18,8	5	1	2	057 7020
	70	25	17	5	1	2	057 7025
	70	30	17,7	5,7	1	2	057 7030
	70	40	17,1	5	1	2	057 7040
	70	50	14,5	5	2	5	057 7050
	80	20	17,6	6	1	2	057 8020
	80	30	14,5	5	1	2,5	057 8030
	80	40	14,5	5	1,0	3,0	057 8040
	80	50	24,5	5	2	4	057 8050
	80	60	24	5	1,5	3,5	057 8060
	90	50	21,5	6	2	4,5	057 8070
	90	70	21,5	6	3	5,5	057 8080
	100	30	14,5	5	1,5	3,5	057 8090
	100	40	14,5	5	1,5	4	057 8100
	100	50	24	5	2	3	057 8110
	100	60	24,5	6	2,5	4,5	057 8120
	100	80	24	6	3	5,5	057 8130
	110	60	24	6	3,5	5,5	057 8140
	110	70	24	6	3	5	057 8150
	120	30	14,5	5	1,5	2,0	057 9030
	120	40	21,5	6	3	5	057 9040
	120	50	21,5	6	3	5,5	057 9050
	120	60	24,5	5	2	4	057 9060
	120	80	24,5	5	2	3	057 9080
	120	100	24	6	3,5	6	057 9100
	140	80	24,5	5	2	4,5	057 9120
	150	50	28	6	2	4	057 9130
	150	100	27,5	7	3	8	057 9140

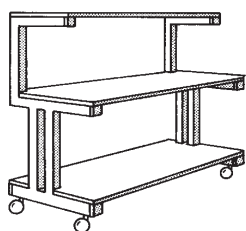

Lamellplugger

Materiale: Polyetylen og nylon 6

Materiale: Polyetylen

For ovale rør

Farge: sort, hvit eller grå

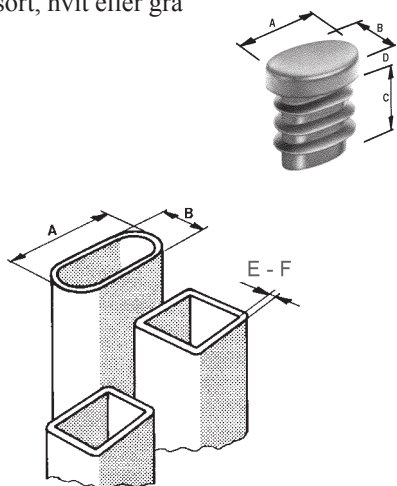

A	B	C	D	E	F	TYPE NR.
20	10	11,5	5	1,5	2,0	145 2010
30	15	11,5	5	1,0	2,5	145 3015
35	15	11,5	5	1,2	2,5	145 3515
35	20	11,5	5	1,5	2,0	145 3520
38	20	11,5	5	1,0	3,0	145 3820
40	20	11,5	4	1,5	2,0	145 4020
48	20	11,5	5	1,5	2,0	145 4820
50	20	11,5	5	1,0	3,0	145 5020
50	25	11,5	5	1	2,5	145 5025
50	30	11,5	5	1	2,5	145 5030
60	20	13	5	1	2	145 6020
60	30	13	5	1	2	145 6030

Materiale: Nylon 6

Med justeringsbein

Farge: sort

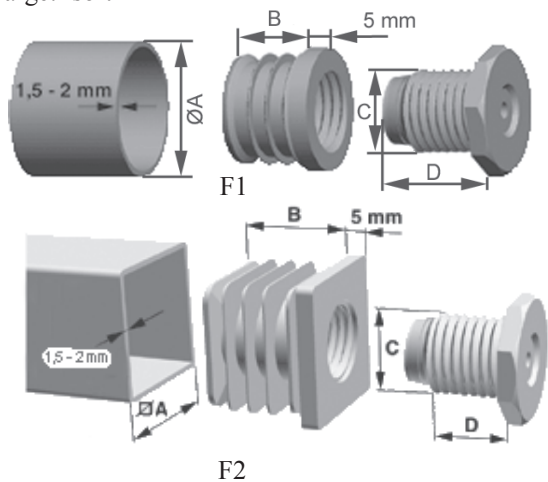

A	B	C	D	E	Type nr.
32	19,5	M22	25	F1	060 0020
35	29	M22	25	F1	060 0030
38	29	M22	25	F1	060 0040
40	29	M22	25	F1	060 0050
45	29	M30	30	F1	060 0060
50	29	M30	30	F1	060 0070
60	35	M42	40	F1	060 0080
20	16,5	M10	25	F2	060 2020
22	16,5	M10	25	F2	060 2222
25	19,5	M16	22	F2	060 2525
30	20	M22	20	F2	060 3030
35	29	M22	25	F2	060 3535
40	29	M22	20	F2	060 4040
45	29	M30	30	F2	060 4545
50	29	M30	28	F2	060 5050

Materiale: Polyetylen

Farge: sort, hvit, grå

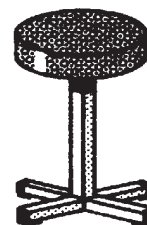
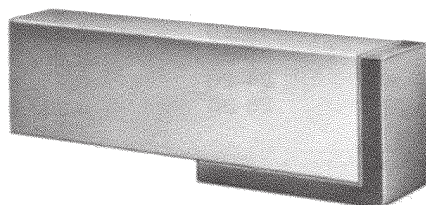
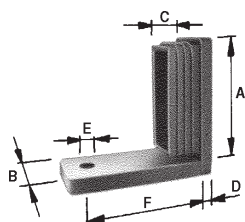

A	B	C	D	E	F	TYPE NR.
25	25	26	5	5,5	14	059 2525
30	30	32	5	5,5	20	059 3030
30	20	12	5	5,3	17	059 3020
40	20	12	5	5,3	41	059 4020

Rørhetter / stolbein

Materiale: Polyetylen og PVC

Farge: sort

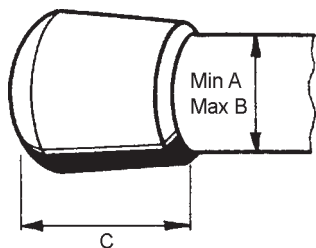

F1

F2



	A	B	C	Fig	TYPE NR.
Materiale: Poethylene, LD	3		10	F1	009 0030
	4		11	F1	009 0040
	5		13	F1	009 0050
	6		13	F1	009 0060
	8		13	F1	009 0080
	10		18	F1	009 0100
	12		18	F1	009 0120
	13		18	F1	009 0130
	14		18	F1	009 0140
	16		18	F1	009 0160
	19		24	F1	009 0190
	22		24	F1	009 0220
	25		24	F1	009 0250
	28		24	F1	009 0280
	Materiale: Z - PVC	30	31	32	F2
32		33	32	F2	009 0320
34			32	F2	009 0340
35		36	32	F2	009 0350
38		39	32	F2	009 0380
40		41	33	F2	009 0400
42			33	F2	009 0420
43		44	33	F2	009 0430
45		46	35	F2	009 0450
47			33	F2	009 0470
48			35	F2	009 0480
49		51	33	F2	009 0490
54		55	35	F2	009 0540
59		60	38	F2	009 0590
63		64	36	F2	009 0630
69	70	38	F2	009 0690	
75	76	38	F2	009 0750	
90		40	F2	009 0900	
103		40	F2	009 1030	

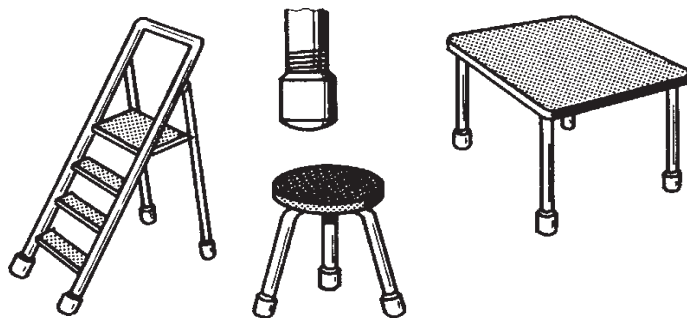

Rørplugger

Materiale: Polyetylen og PVC

Farge: sort

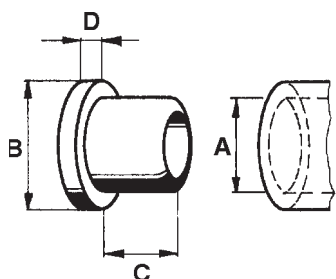

	A	B	C	D	Fig	TYPE NR.
	Materiale: Polethylen, LD					
	8	11	8	2,5	F1	045 0800
	10	13	8	2,5	F1	045 1000
	12	15	10	3	F1	045 1200
	13	16	10	3	F1	045 1300
	14	17	10	3	F1	045 1400
	15	18	10	3	F1	045 1500
	16	19	12	3,5	F1	045 1600
	17	20	12	3,5	F1	045 1700
	18	22	12	3,5	F1	045 1800
Materiale: Z - PVC						
	19	25	20	6	F2	045 1900
	20	25	20	7	F2	045 2000
	21	26	20	7	F2	045 2100
	22	27	20	7	F2	045 2200
	23	29	20	7	F2	045 2300
	24	29	20	8	F2	045 2400
	25	30	20	8	F2	045 2500
	26	32	20	9	F2	045 2600
	27	31	20	9	F2	045 2700
	28	35	22	7	F2	045 2800
	29	36	22	7	F2	045 2900
	40	45	25	9	F2	045 4000

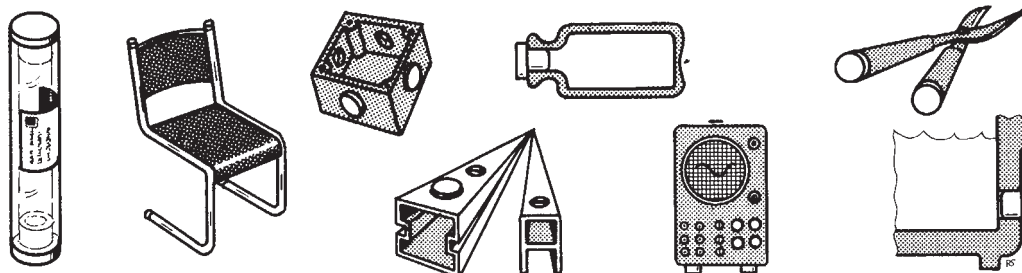

Rørplugger

Materiale: Polyetylen, LD

Farge: sort, hvit eller grå

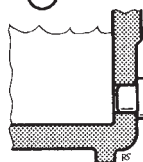
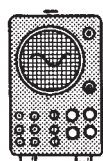
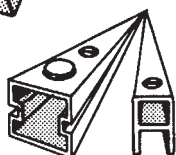
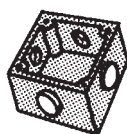
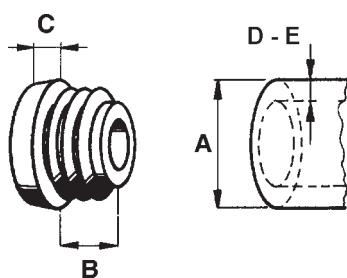

	A	B	C	D	E	Type nr.
10	12	12	3,5	1,5	2,0	085 0100
12	12	12	3,5	1,5	2,0	085 0120
13	12	12	4	0,8	2,0	085 0130
14	12	12	5	1,5	2,0	085 0140
15	12	12	3	0,8	2,0	085 0150
16	12	12	5	0,8	2,0	085 0160
18	12	12	5	0,8	2,0	085 0180
19	12	12	5	0,8	2,0	085 0190
20	12	12	5	0,8	2,5	085 0200
21	12	12	5	1,5	2,0	085 0210
22	12	12	5	1,0	3,0	085 0220
23	12	12	5	1,5	2,0	085 0230
24	12	12	5	1,5	2,0	085 0240
25	12	12	5	1,0	2,5	085 0250
26	12	12	5	1,5	2,0	085 0260
27	12	12	5	1,0	3,0	085 0270
28	12	12	5	0,8	2,5	085 0280
30	12	12	5	1,5	2,0	085 0300
32	12	12	5	0,8	2,5	085 0320
34	12	12	5	1,0	3,0	085 0340
35	12	12	5	1,0	2,5	085 0350
36	12	12	5	1,5	2,0	085 0360
37	12	12	5	1,5	2,0	085 0370
38	12	12	5	1,5	3,5	085 0380
40	12	12	5	1,0	3,0	085 0400
42	12	12	5	0,8	2,5	085 0420
43	12	12	5	2,0	2,5	085 0430
45	12	12	5	0,8	3,5	085 0450
48	12	12	5	1,2	3,6	085 0490
50	12	12	5	1,0	3,0	085 0500
55	12	12	5	1,0	3,0	085 0550
60	19	19	4	1,5	3,0	085 0600
65	21	21	5	1,5	3,5	085 0650
70	21	21	5	2	4,5	085 0700
76,1	21	21	5	1,8	4	085 0761
80	21	21	4	1,5	3	085 0800
88,9	21	21	5	1,8	4	085 0889
90	21	21	6	2,5	5	085 0900
100	28	28	6	2	4,5	085 1000
110	28	28	6	2	4,5	085 1100
120	28	28	6	2	4	085 1200
140	34	34	6	2	6,5	085 1400
150	34	34	6	2	7	085 1500
160	34	34	5	5	7	085 1600
168,3	34	34	5	2	6,5	085 1683

Beskyttelseshette

Materiale: Polyetylen, myk

Farge: naturell

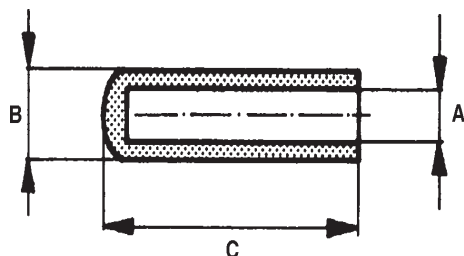

A	B	C	TYPE NR.
3,5	5	23	118 0322
4	6	23	118 0423
4,7	7	15	118 0515
5	7	24	118 0524
6	8	25	118 0625
7	9	25	118 0725
8	10	25	118 0825
10	12	25	118 1025

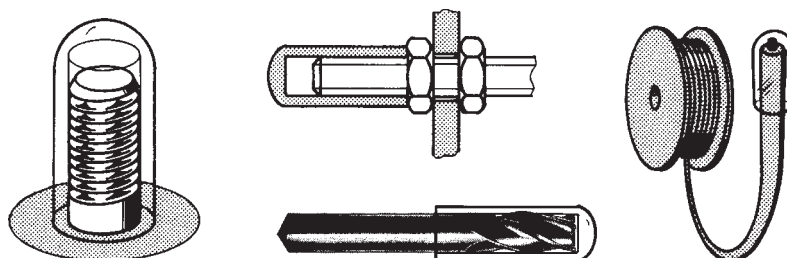

Rørmøbelfot

Materiale: Polyetylen

Farge: sort eller hvit

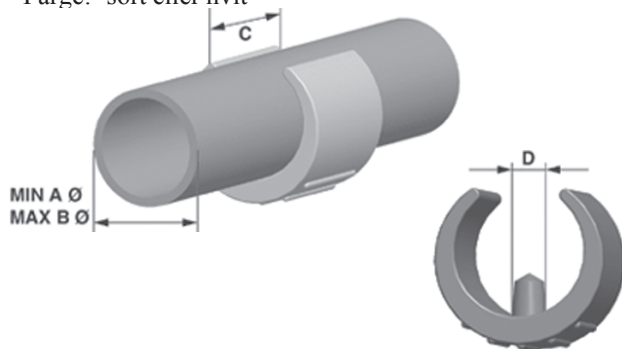

A	B	C	D	TYPE NR.
14	16	18	5,5	147 0150
16	18	19	5,8	147 0170
18	20	20	5,8	147 0190
20	22	22	5,8	147 0210
24	26	25	5,8	147 0250
28	30	30	7,5	147 0290

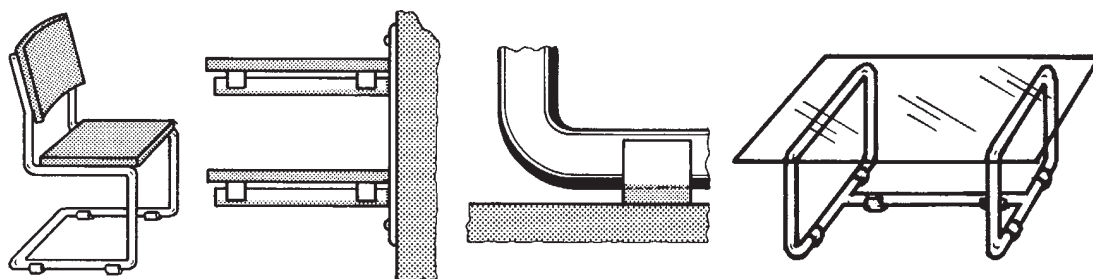

D

Bein, underlagsknotter

Farge: sort

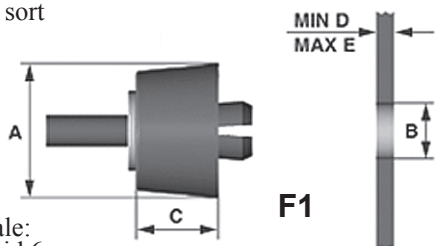
Materiale:
Polyamid 6

F1

Farge: sort

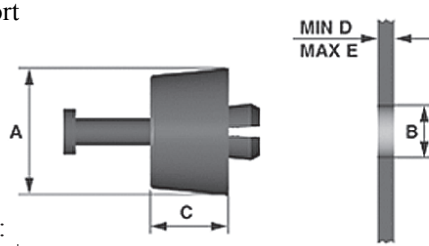
Materiale:
Elestomer +
Polypropylene

A	B	C	D	E	Fig	Type nr.
12	6	3,7	0,8	2	F1	120 0412
16	7	7	1,5	3	F1	120 0716
16	7,7	12	0,9	1,5	F1	120 1316
17	7	11	1	2,5	F1	120 1117
21	7,7	15	0,8	4	F1	120 1521

A	B	C	D	E	Fig	Type nr.
14	3,1	5	0,8	1,8	F2	120 5050
20	8,1	10	0,8	1,5	F2	120 6150
20	8,1	15	0,8	1,5	F2	120 6200
20	8,1	15	0,8	1,5	F2	120 6250
20	8,1	18	0,8	1,5	F2	120 6300
21	8,1	6	5	8	F2	120 6100
25	8,1	5	0,8	1,5	F2	120 6050

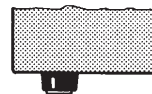
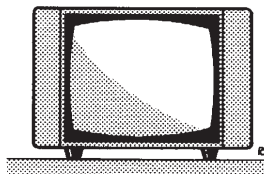
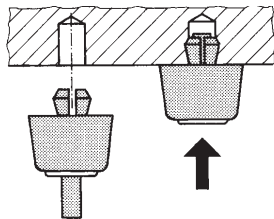

Materiale: Plastikk, myk

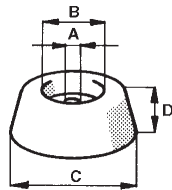
Farge: sort 114
hvit 113

A	B	C	D	TYPE NR.
3,2	6	15	7,5	048 1500
4,3	8	20	10	048 2000
4,3	10	25	12,5	048 2500
5,3	12	30	15	048 3000

Farge: sort

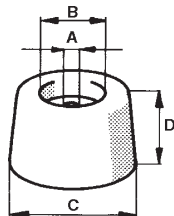

A	B	C	D	TYPE NR.
4,2	9	19,5	23	066 0200
5,2	11	24,5	25	066 0250
7	12	30,5	25	066 0300

Materiale: Plastikk, myk

Farge: sort

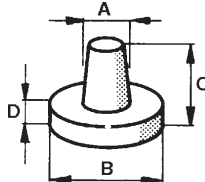

A	B	C	D	TYPE NR.
3	8	10	3	049 0800
4	12	10	3	049 1200
5	13	13	3	049 1300
5	16	10	4	049 1600

Bein

Materiale: Plastikk, myk

Farge: sort

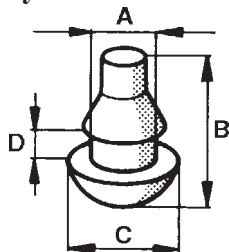

A	B	C	D	TYPE NR.
6	19	10	2,5	047 0600

Materiale: Plastikk, myk

Farge: grå

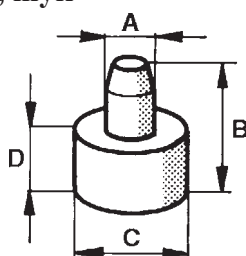

A	B	C	D	TYPE NR.
4,7	12	10	7	068 0100

**Materiale: Polyurethan
+ Selvklebende**

Leveres i ark. Antall enheter pr. ark står i kolonnen ANT.

Farge: 117 xxxx 699 - Sort
117 xxxx 600 - Hvit
117 xxxx 000 - Transparent

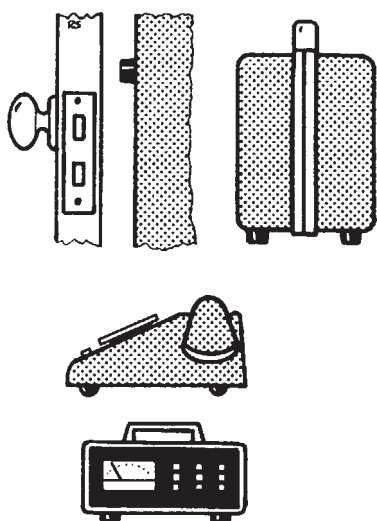

	A	B	ANT.	TYPE NR.
	8	2,8	56	117 1017 699
	12,7	1,3	20	117 1023 669
	12,7	3,5	56	117 1011 600
	12,7	3,5	56	117 1011 699
	12,7	6,5	30	117 1016 699
	19	4,0	20	117 1018 699
20	5,0	24	117 1019 699	
	8	2,2	204	117 1012 000
	9,5	3,8	48	117 1020 000
	11	5,0	56	117 1004 000
	11	5,0	56	117 1004 600
	11	5,0	56	117 1004 699
	16	8,0	40	117 1005 699
19	9,6	20	117 1021 699	
	22	10,0	24	117 1006 699
	10,2	2,5	54	117 1022 699
	12,7	3,1	80	117 1013 600
	12,7	3,1	80	117 1013 699
	12,7	3,4	28	117 1024 699
	12,7	5,4	28	117 1025 699
	12,7	5,8	80	117 1014 699
	20,5	7,6	36	117 1010 699

Murplugger

Materiale: Nylon 6

Farge: grå RAL 9002

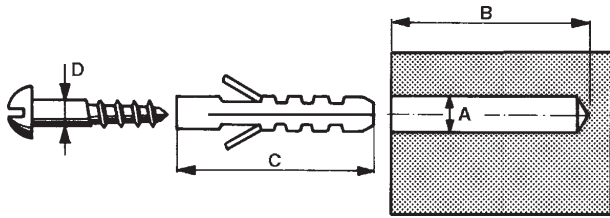

A	B	C	D	TYPE NR.
4	25	20	2,0 - 3,0	108 0104
5	32	25	2,5 - 4,0	108 0105
6	40	30	3,5 - 4,0	108 0106
8	55	40	4,5 - 6,0	108 0108
10	70	50	6,0 - 8,0	108 0110
12	80	60	8,0 - 10,0	108 0112
14	95	75	10,0 - 12,0	108 0114

Plomber

Materiale: Sealon

Farge: grå

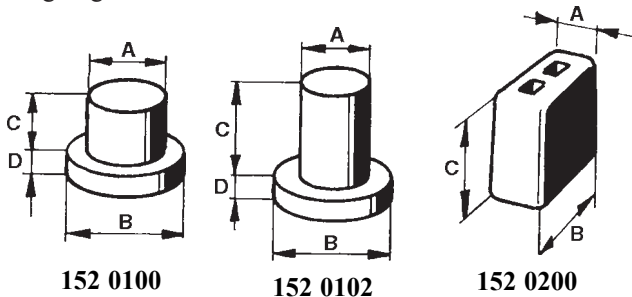

A	B	C	D	TYPE NR.
6,4	9	4,5	2,1	152 0100
4,9	9	7,5	2	152 0102
5	9	9		152 0200

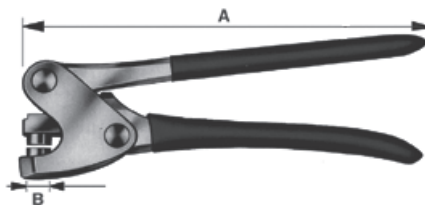

Plomberingstang 152 0001

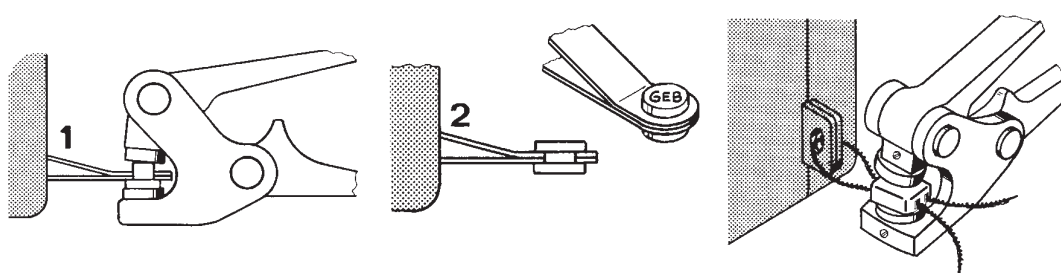

Bevegelsesdempere

Materiale: Plast

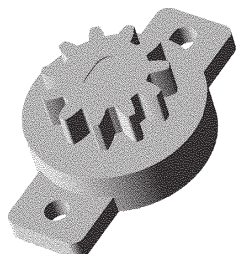

Dreiemoment: ved 20°C og 20 rpm	Farge på hjul	TYPE NR.
0,20 Ncm	Gul	078 0005
0,4 Ncm	Brun	078 0010
0,95 Ncm	Hvit	078 0015
1,2 Ncm	Blå	078 0020

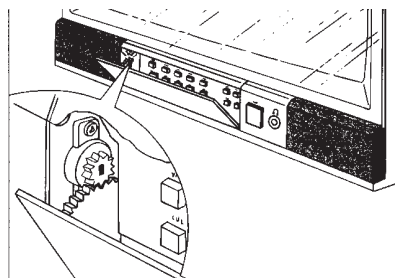
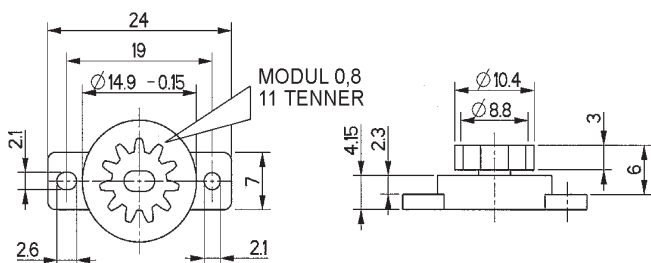

D

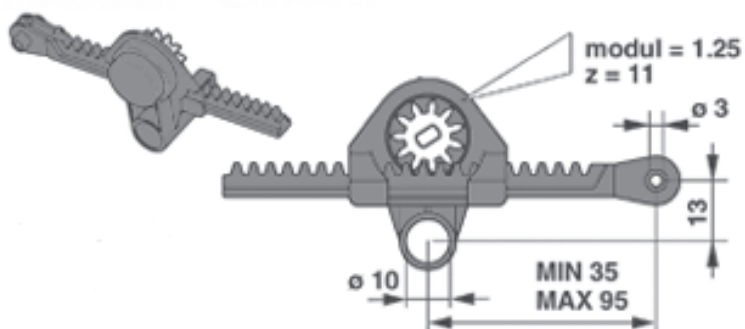

Dreiemoment: ved 20°C og 20 rpm	Farge på hjul	TYPE NR.
1,2 Ncm	Blå	078 0020

For egne notater: